

## VL-2020

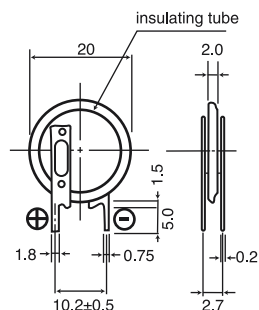

## SPECIFICATIONS

Name	VL-2020
Nominal voltage (V)	3
Nominal capacity (mAh)	20.0
Continuous drain (mA)	0.07
Operating temperature (°C)	-20 to +60
Weight (g)	2.2

## DISCHARGE TEMPERATURE CHARACTERISTICS

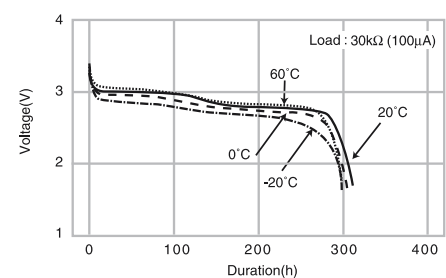

## CONSUMPTION CURRENT VS. DURATION TIME

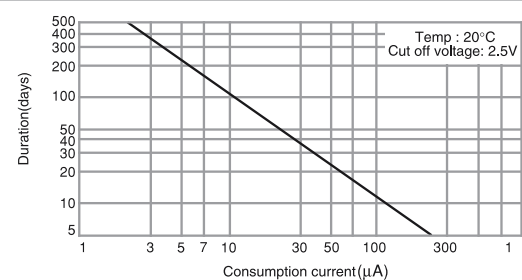

## VL-2320

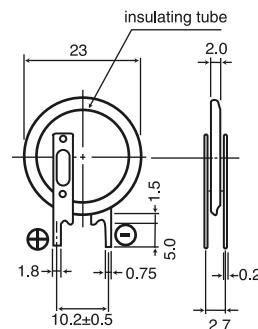

## SPECIFICATIONS

Name	VL-2320
Nominal voltage (V)	3
Nominal capacity (mAh)	30.0
Continuous drain (mA)	0.1
Operating temperature (°C)	-20 to +60
Weight (g)	2.7

## DISCHARGE TEMPERATURE CHARACTERISTICS

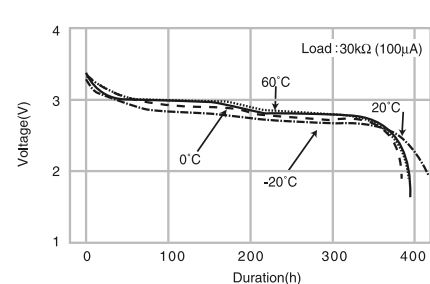

## CONSUMPTION CURRENT VS. DURATION TIME

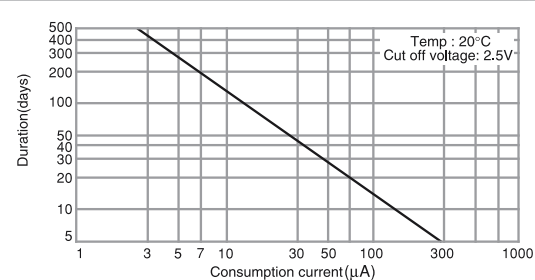

## VL-2330

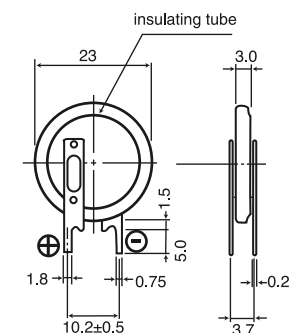

## SPECIFICATIONS

Name	VL-2330
Nominal voltage (V)	3
Nominal capacity (mAh)	50.0
Continuous drain (mA)	0.1
Operating temperature (°C)	-20 to +60
Weight (g)	3.5

## DISCHARGE TEMPERATURE CHARACTERISTICS

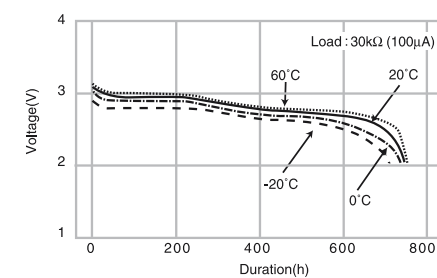

## CONSUMPTION CURRENT VS. DURATION TIME

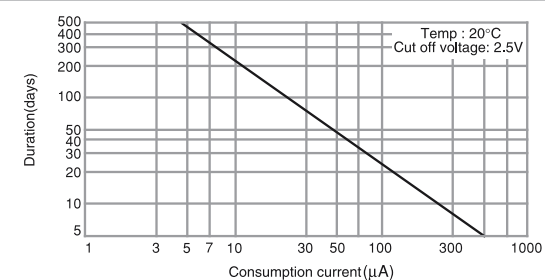

## VL-3032

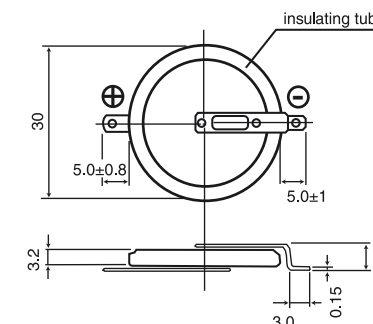

## SPECIFICATIONS

Name	VL-3032
Nominal voltage (V)	3
Nominal capacity (mAh)	100.0
Continuous drain (mA)	0.2
Operating temperature (°C)	-20 to +60
Weight (g)	6.2

## DISCHARGE TEMPERATURE CHARACTERISTICS

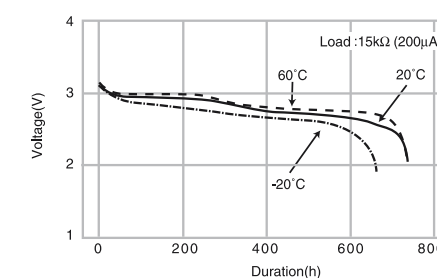

## CONSUMPTION CURRENT VS. DURATION TIME

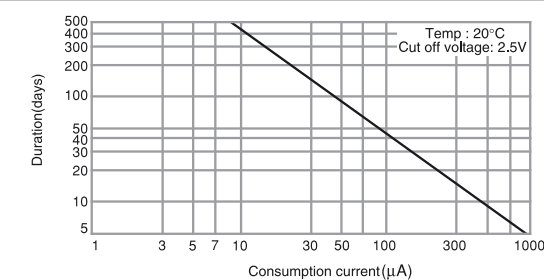

## CYCLE LIFE (VL SERIES)

